

- | | |
|---|---|
| DE Superenergiesparende Kniestocktür | LV Superizolējošā sienas lūka |
| EE Väga energiasäästlik seinaluuk | NL Superisolerend knieschotdeur |
| FI Erinomaisella lämpöeristeellä L-muotoinen yhdistelmäovi | PL Supertermoizolacyjne drzwi z kolankowce |
| FR Portillon de comble thermo-isolant | RU Суперэнергоберегающие карнизные двери |
| GB Highly insulated L-shaped combination door | SK Super tepelizolačné podkrovné dveria |
| IT Porta ad angolo supertermoisolante | UA Суперенергозберігаючі карнізні двері |

DWT

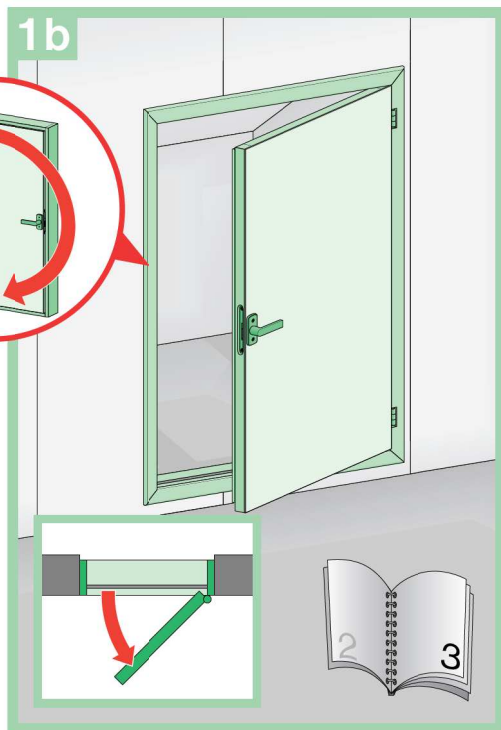

1a

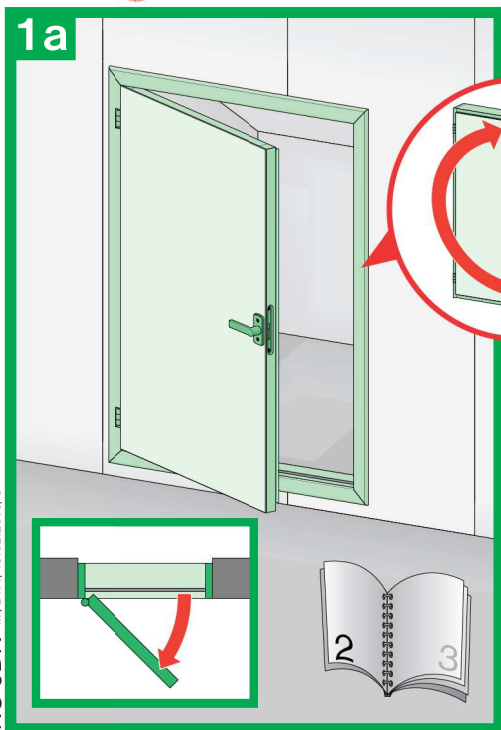
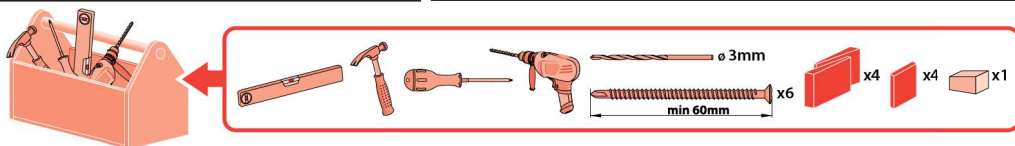
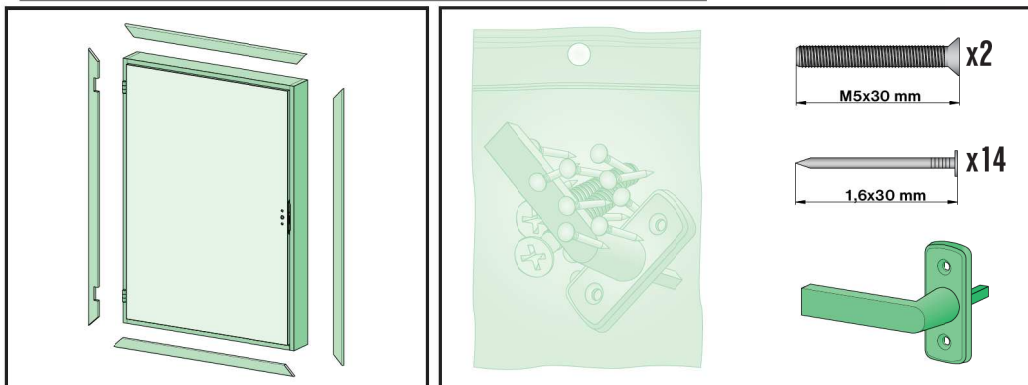
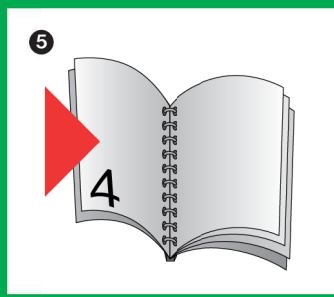
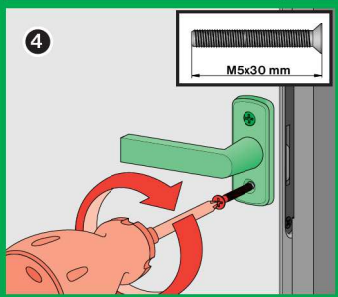
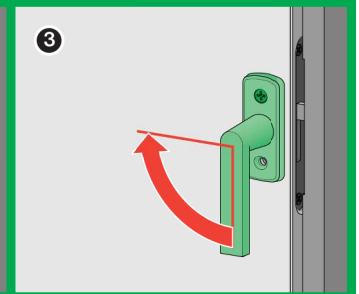
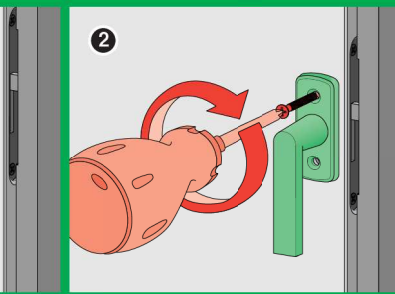
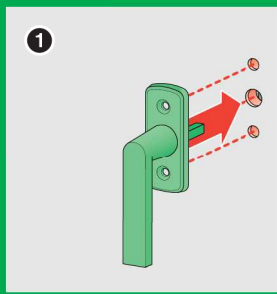
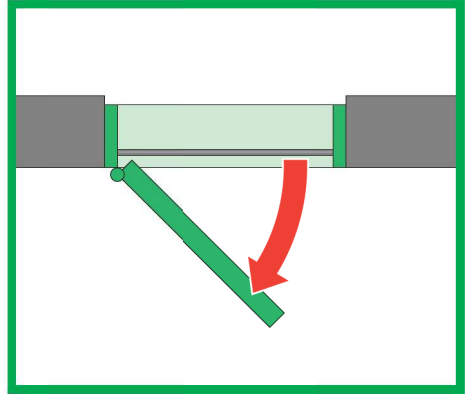
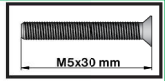
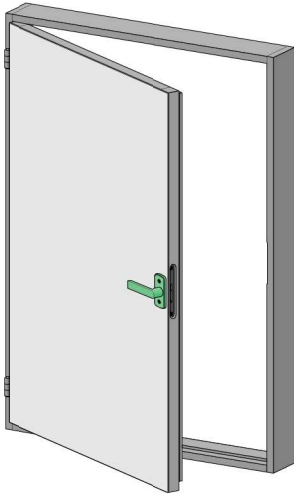

1b

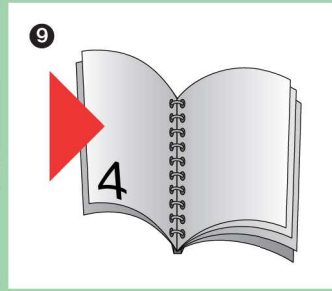
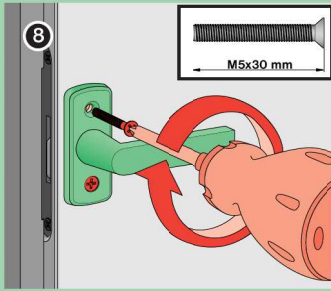
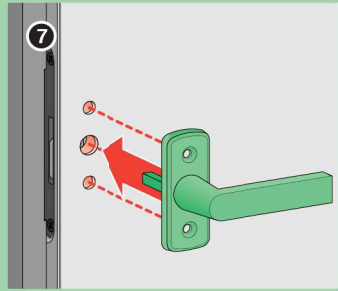
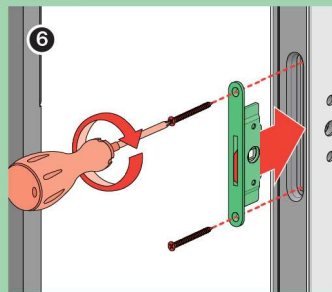
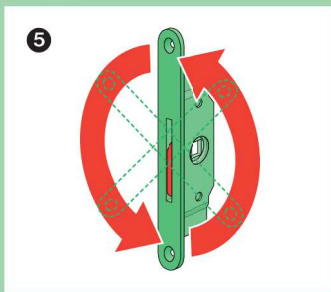
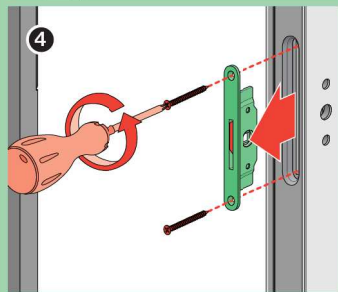
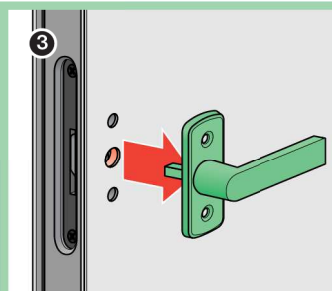
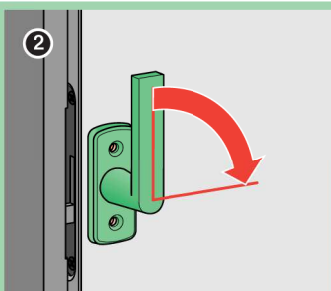
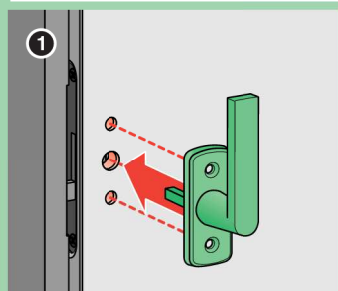
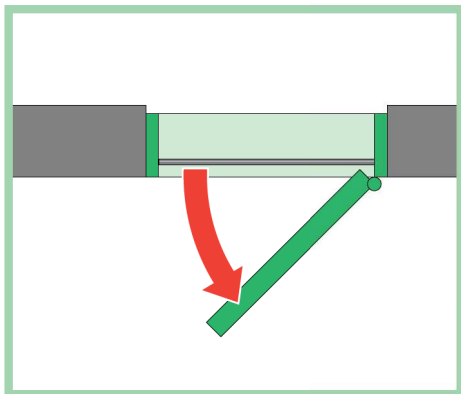
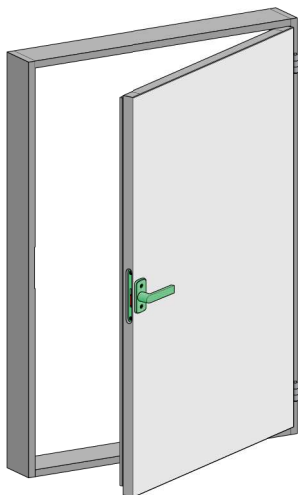

2

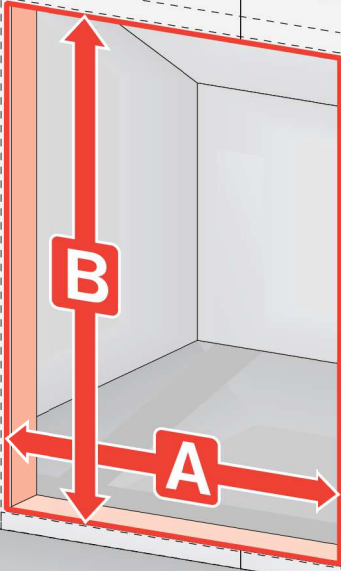

DWT	
A x B cm	
NR. ART. 869600	
Info: www.fakro.com	
~ <input type="text"/> kg	W = <input type="text"/> cm
~ <input type="text"/> m ³	L = <input type="text"/> cm

3a

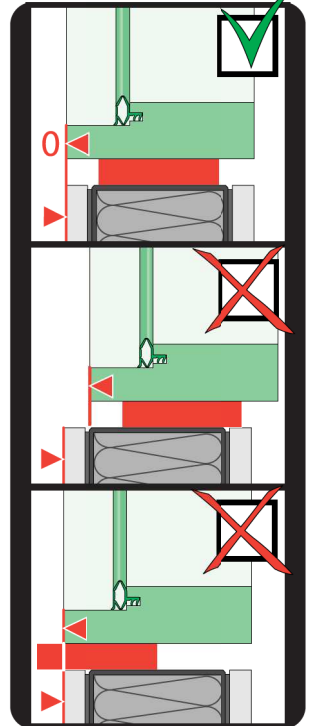
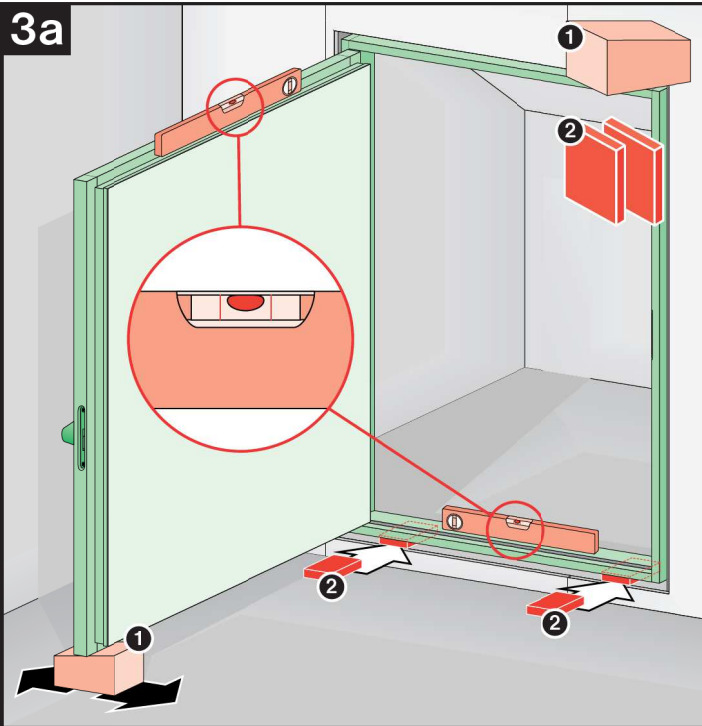

3b

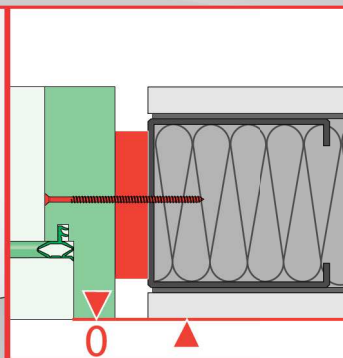
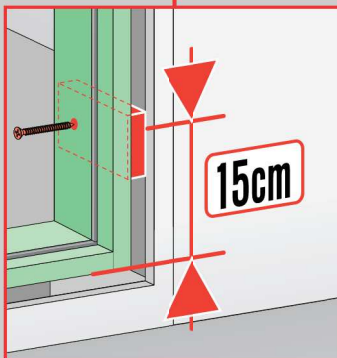
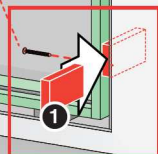
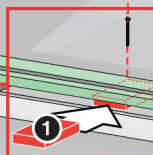
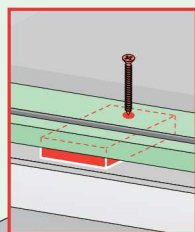
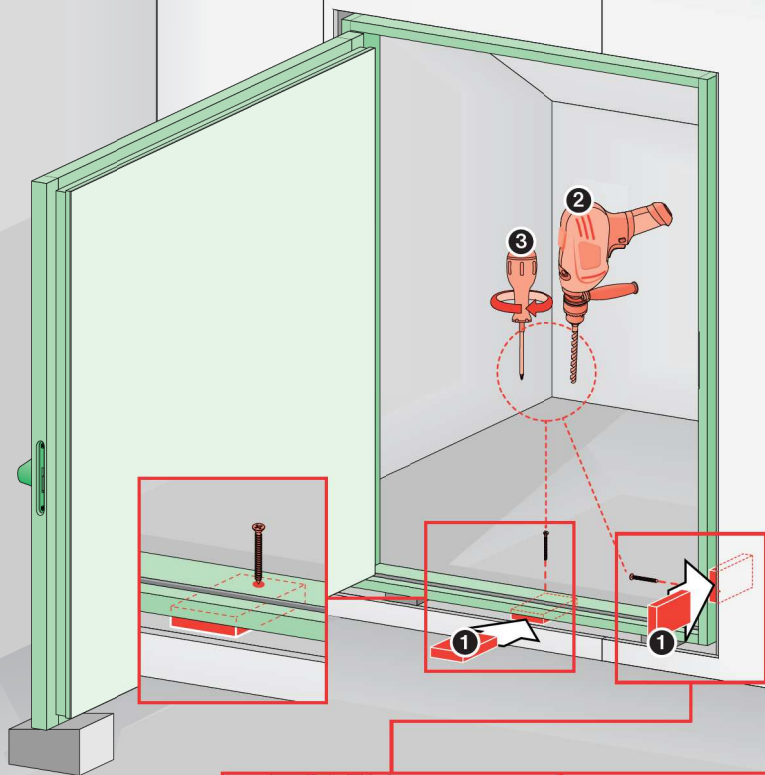
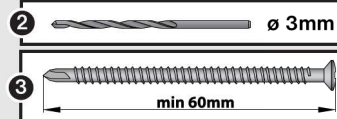

3c

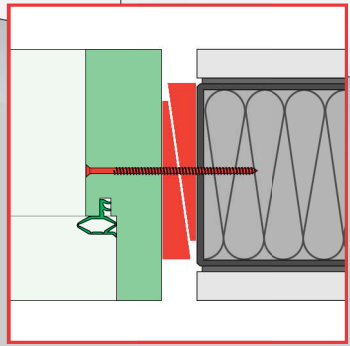
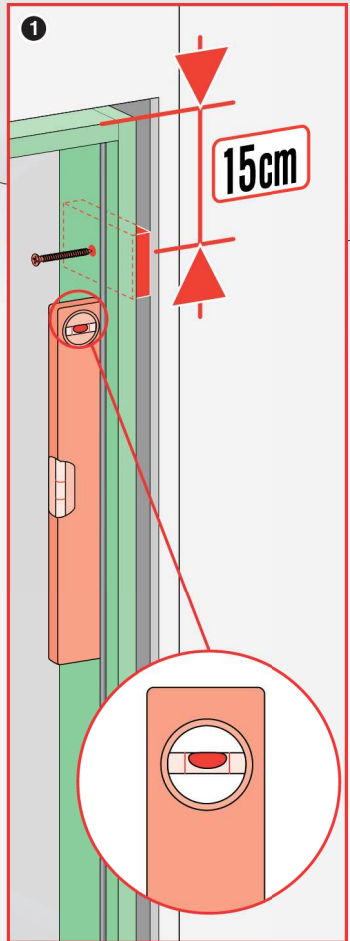
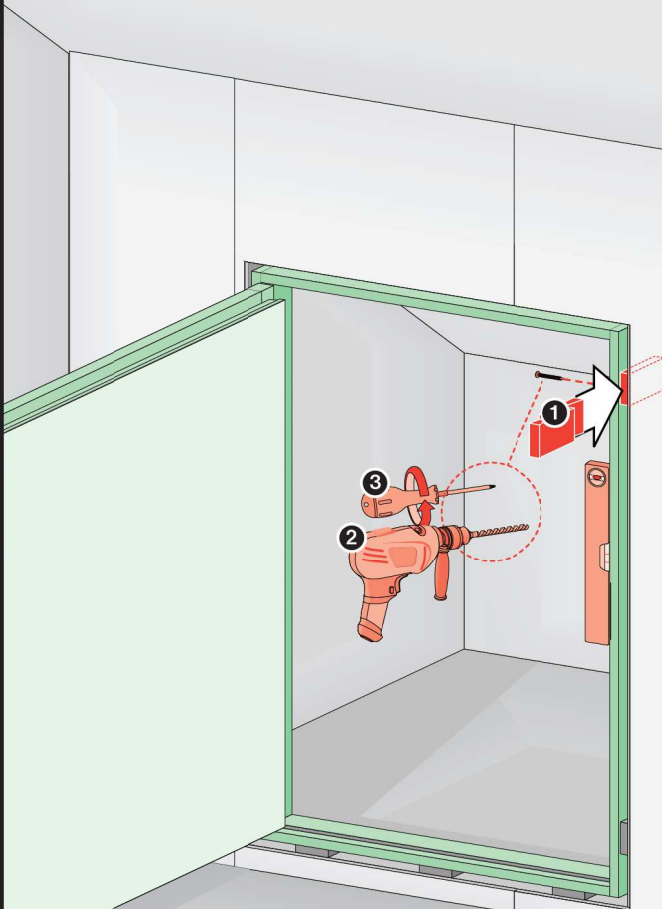
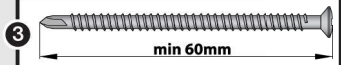

4a

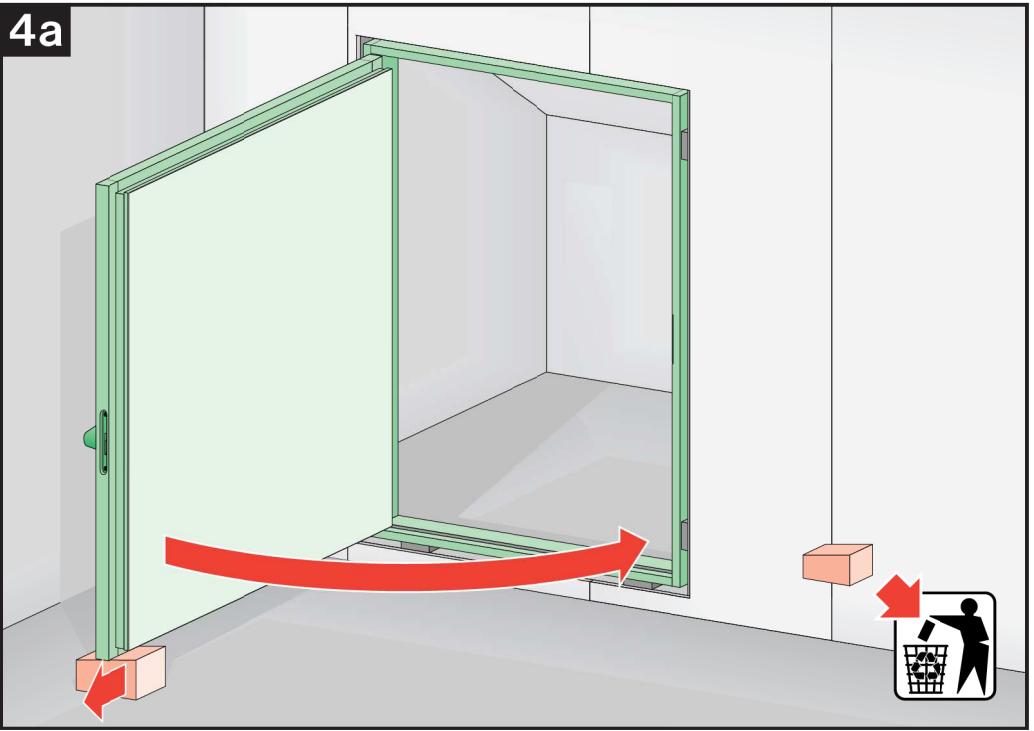

4b

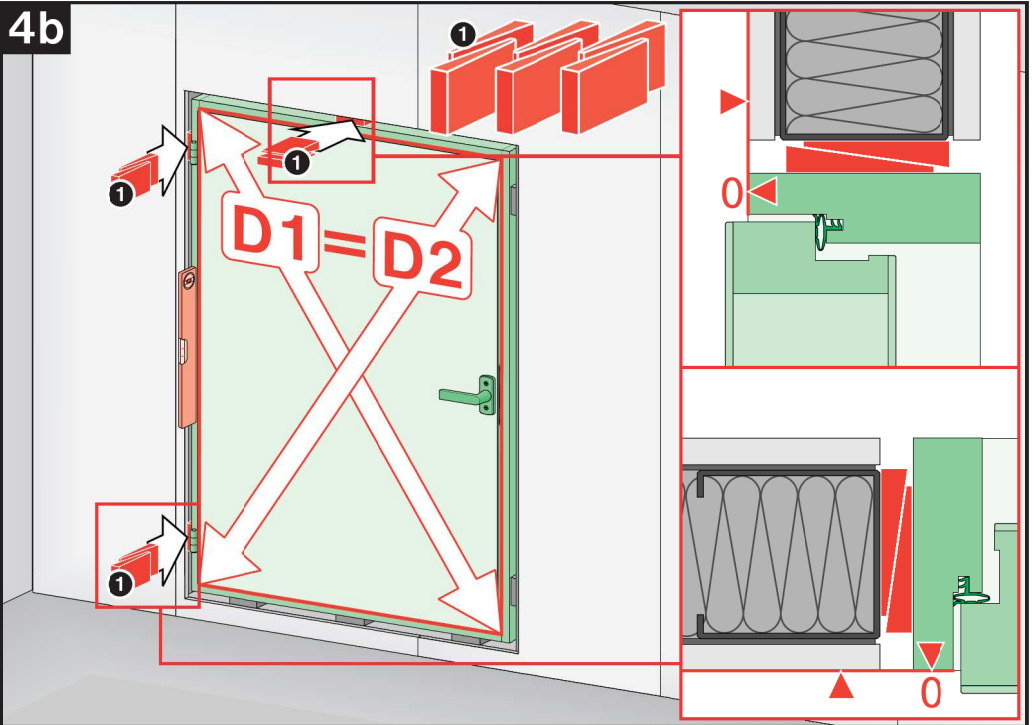

4c

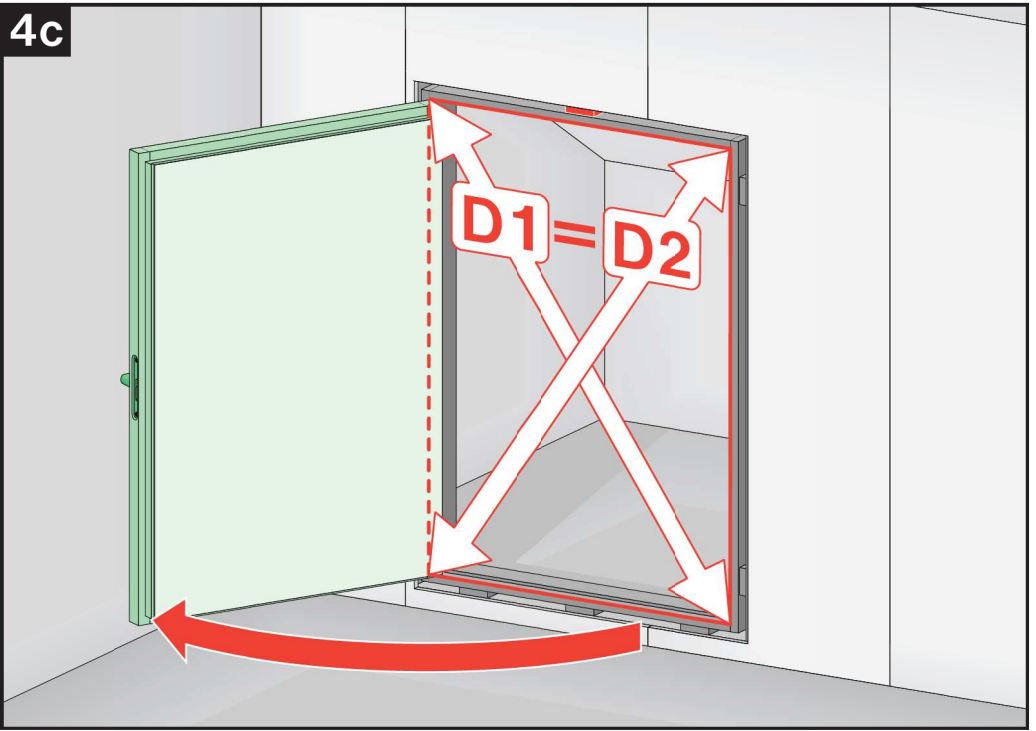

4d

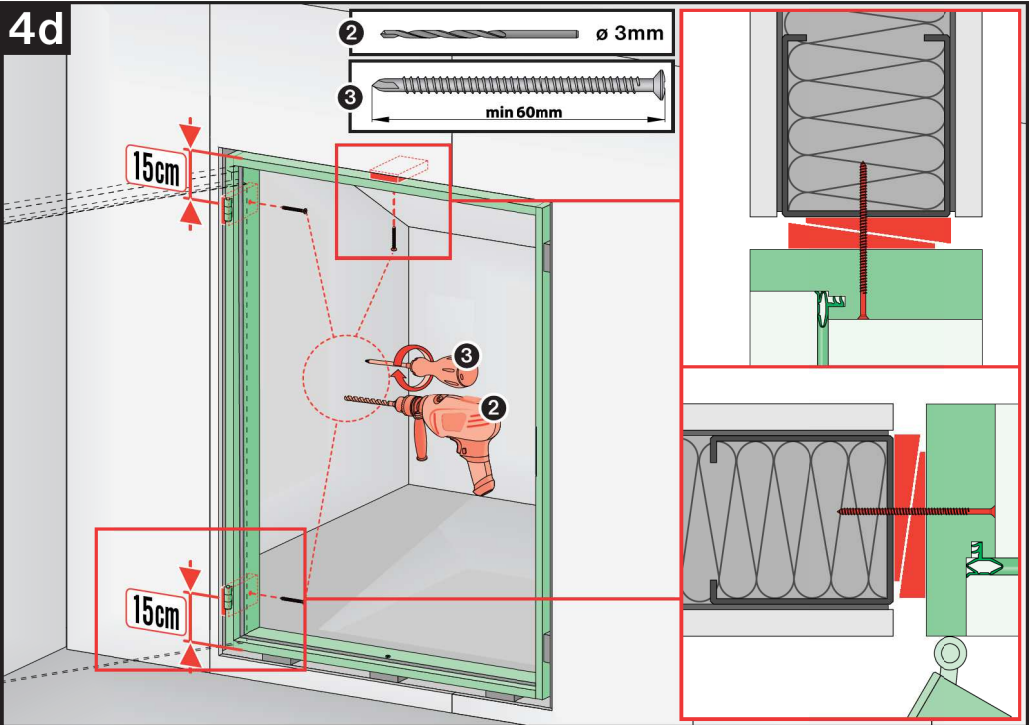

4e

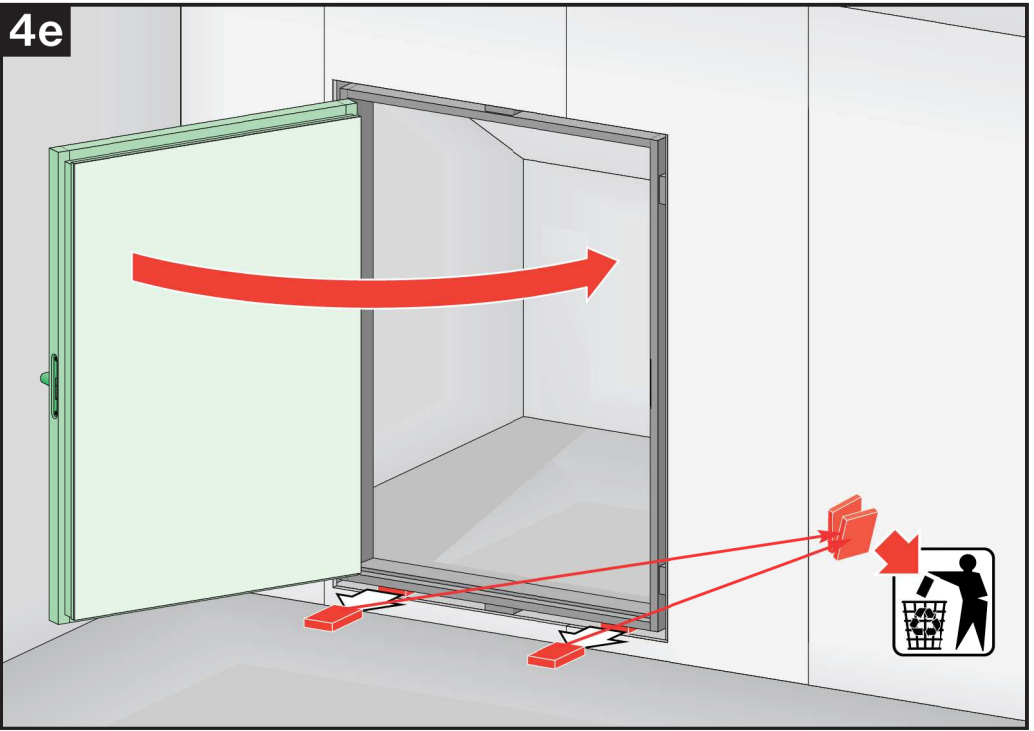

5

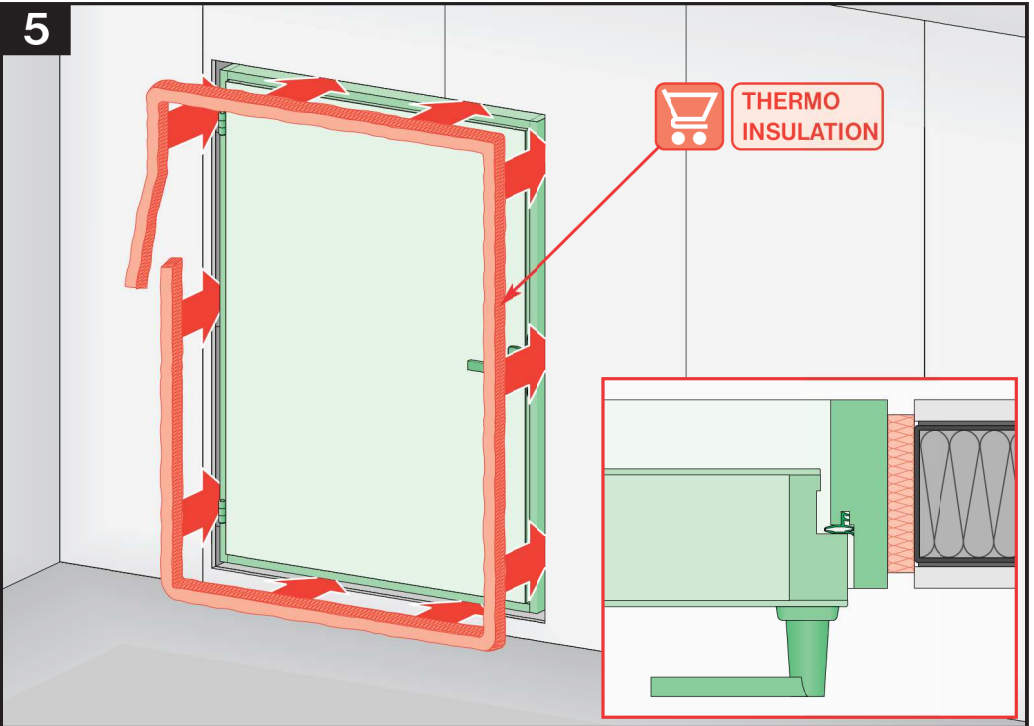

6

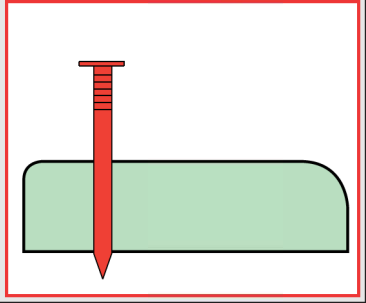
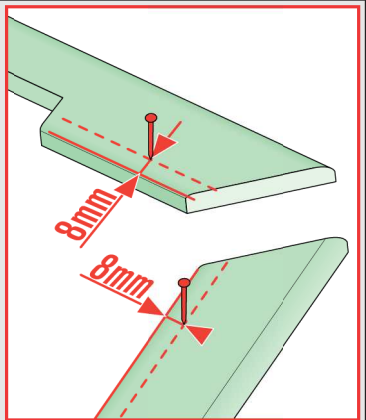
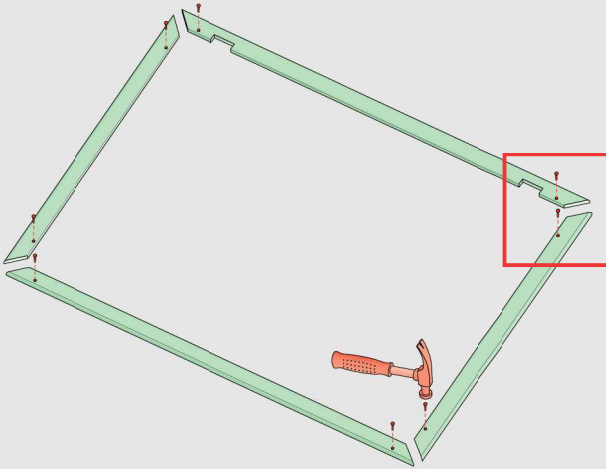
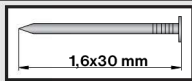

7a

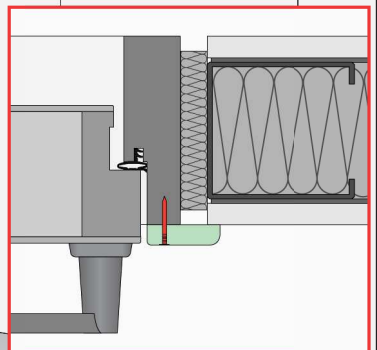
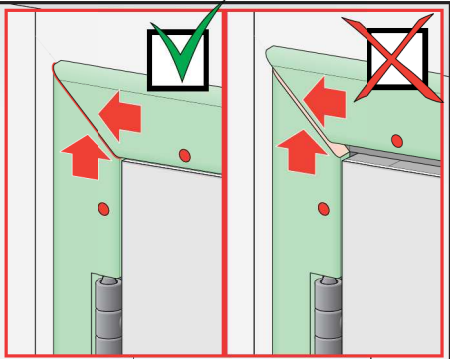
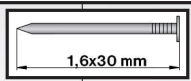

7b

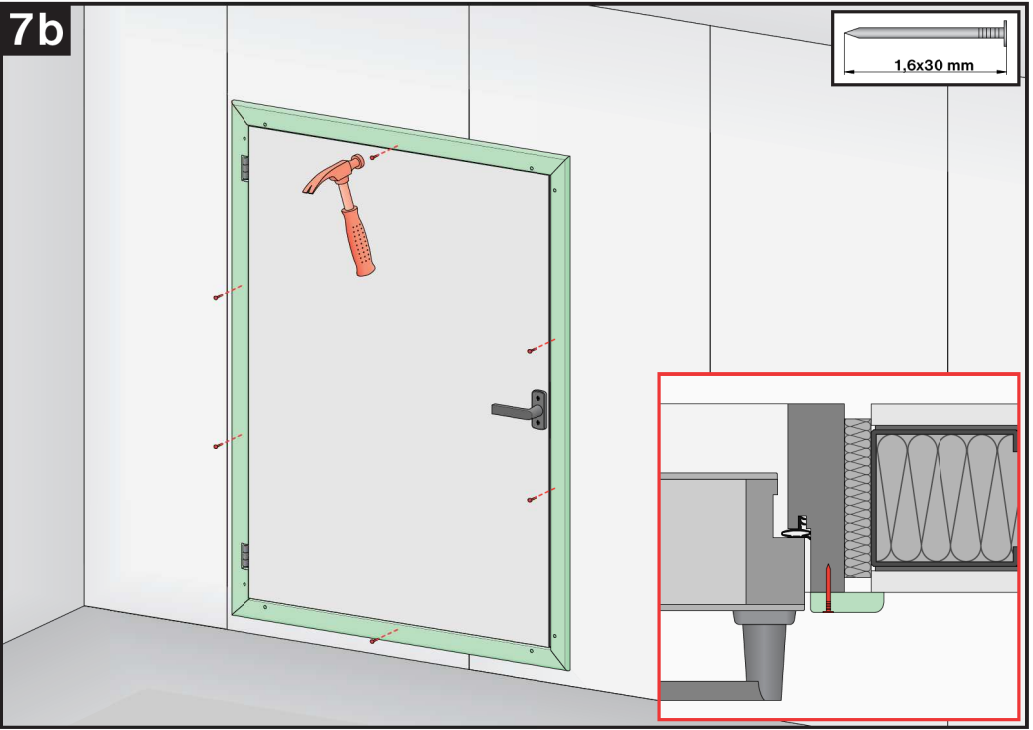
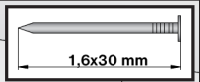

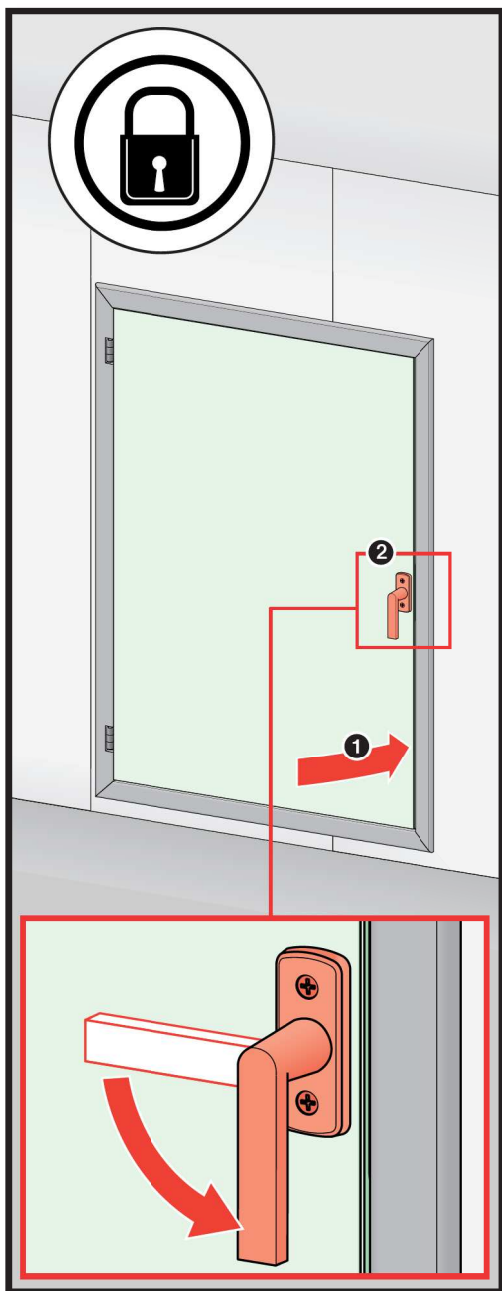
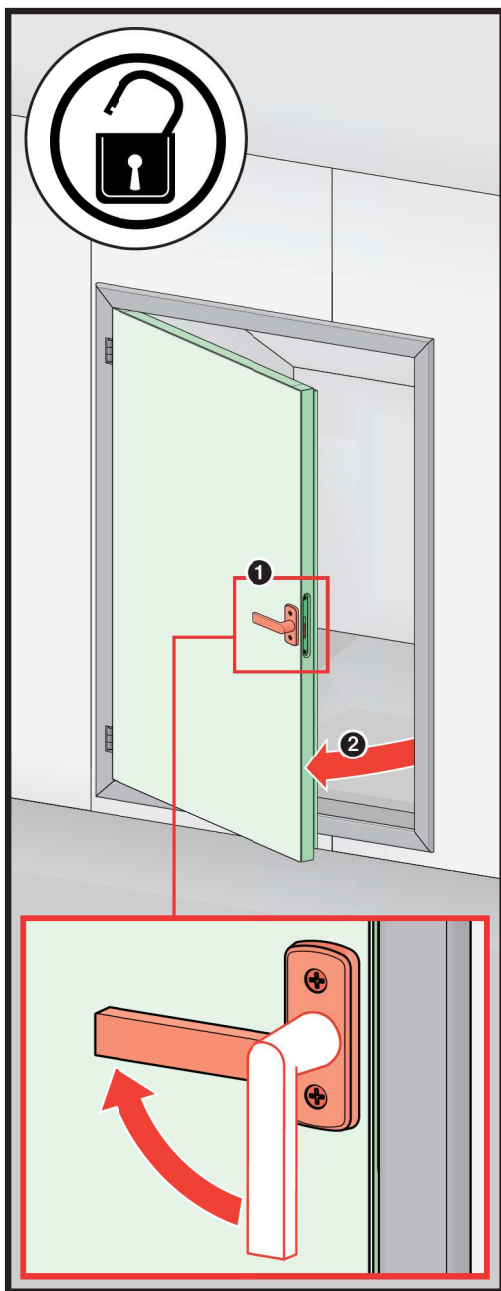

CZ Výrobce a Prodávce nenesú žádnou odpovědnost za nedodržení příslušných předpisů zákona, stavebních předpisů a bezpečnostních požadavků plet uživatelé výrobků, architekti, montéři nebo majitelé objektu.

ES El fabricante y el vendedor no tienen ninguna responsabilidad por el incumplimiento de la ley vigente, normas de construcción y exigencias de seguridad por parte del usuario del producto, arquitecto, instalador o el propietario del edificio.

GB Manufacturer and Seller shall bear no liability for failure to comply with the applicable laws, building codes and safety requirements by the user of the product, architect, fitter or owner of the building.

IT Il Produttore e il Venditore non potranno essere ritenuti responsabili per il mancato rispetto, da parte dell'utente del prodotto, del progettista, dell'installatore o del proprietario dell'edificio, delle leggi vigenti, nonché dei regolamenti edilizi e di quelli relativi alla sicurezza.

PL Producent i Sprzedawca nie ponosi żadnej odpowiedzialności za nieprzeżyczenie stosownych przepisów prawa, przepisów budowlanych i wymogów bezpieczeństwa przez użytkownika produktu, architekta, montażystę lub właściciela budynku.

RO Nici producătorul, nici distribuătorul nu sîi vor asuma niciun fel de răspundere pentru nerespectarea legilor în vigoare, a regilor din domeniul construcțiilor sau a măsurilor de siguranță impuse utilizatorilor produsului, arhitecților, montajistilor sau proprietarilor clădirii.

SK Výrobca a predávka nenesú žiadnu zodpovednosť za nedodržanie príslušných ustanovení zákona, stavebných predpisov a bezpečnostných požiadaviek užívateľom výrobku, architektom, montážnym alebo majiteľom objektu.

DE Hersteller und Verkäufer übernehmen keine Haftung für Nichtbeachtung entsprecheuder Rechts- und Bauvorschriften sowie Sicherheitsanforderungen seitens Produktbenutzers, Architekten, Monteure oder Gebäudebesitzer.

FR Le fabricant et le vendeur ne prend aucune responsabilité de ne pas respecter les lois applicables, les règlements sur les bâtiments et les exigences de sécurité par l'utilisateur du produit, l'architecte, l'installateur ou le propriétaire du bâtiment.

HU A Gyártó és a Forgalmazó nem vállal semmiféle felelősséget a vonatkozó törvényi, építési és biztonsági előírások teremtésbűsznáci, építész, telepítőmester vagy épületajadónos általi nem tartásáért.

NL De fabrikant en verkoper zijn niet aansprakelijk voor gevolgen bij het niet opvolgen van toepasselijke wetten, bouwbesluiten en veiligheidsvoorschriften door de gebruiker van het product, de architect, de installateur of de eigenaar van het gebouw.

PT O fabricante e o vendedor não tem nenhuma responsabilidade pelo o não cumprimento da lei, códigos de construção e as exigências de segurança por parte do usuário do produto, arquiteto, instalador ou proprietário do edifício.

RU В случае несоблюдения архитектором, монтажником или владельцем здания строительных правил и норм безопасности ответственность производителя и продавца снимается.