

B - B

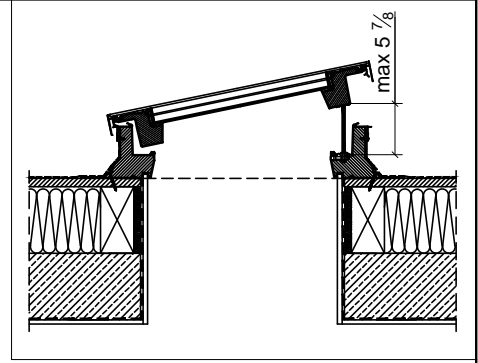

A - A

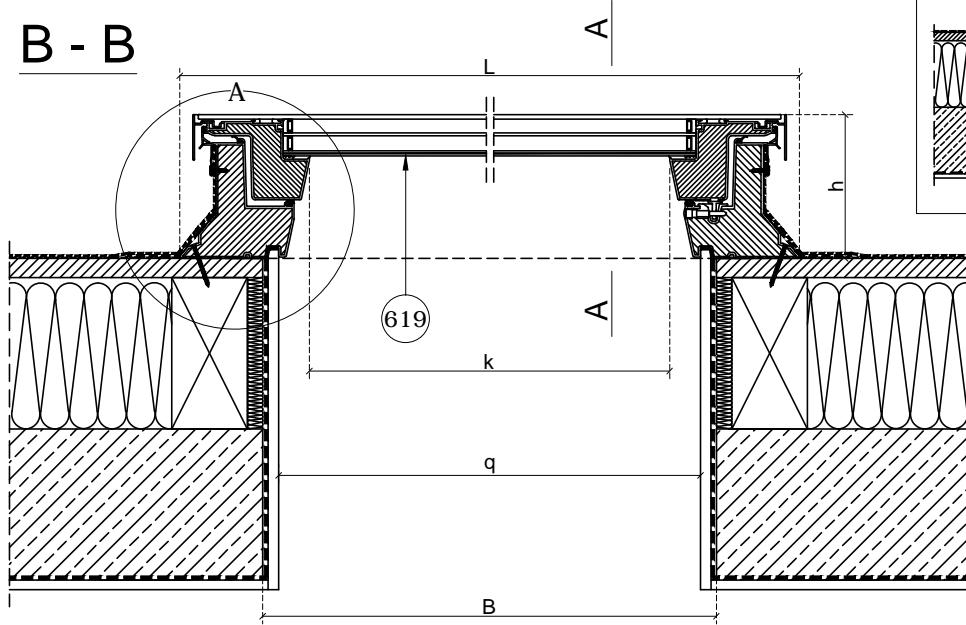
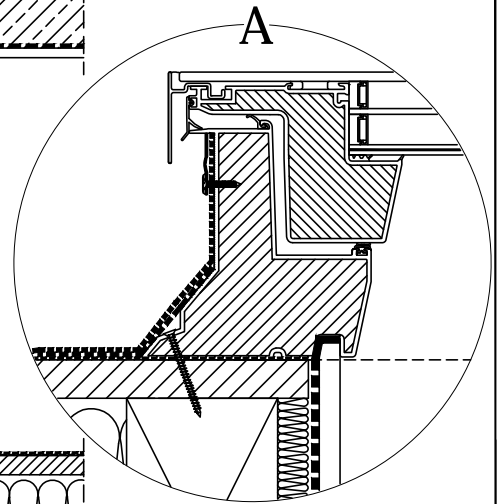
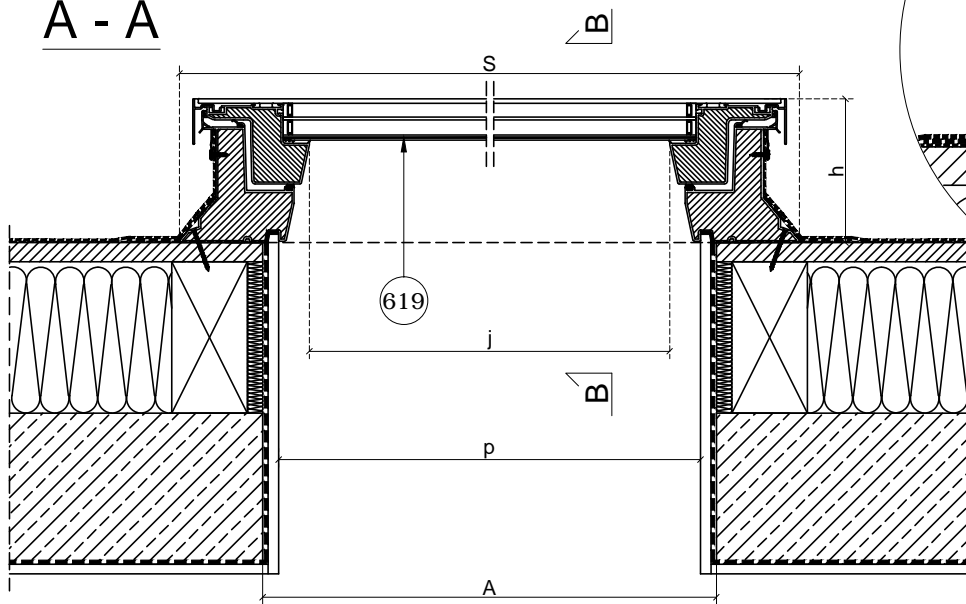

619-DEF DU6 Flat Roof Window, electrically opened, glazing unit DU6

DEF DU6 - DIMENSIONS

Window size [inch]	Size symbol	Height [inch]	Rough opening [inch]		Outside frame [inch]		Distance between lining grooves [inch]		Glazing size [inch]	
			A	B	S	L	p	q	j	k
30"x30"	54K	7 1/2"	29 7/8"	29 7/8"	39 1/4"	39 1/4"	28 7/8"	28 7/8"	25 5/8"	25 5/8"
30"x36"	56K	7 1/2"	29 7/8"	34 3/4"	39 1/4"	44 1/8"	28 7/8"	33 3/4"	25 5/8"	30 1/2"
36"x36"	57K	7 1/2"	34 3/4"	34 3/4"	44 1/8"	44 1/8"	33 3/4"	33 3/4"	30 1/2"	30 1/2"
36"x48"	58K	7 1/2"	34 3/4"	46 5/8"	44 1/8"	55 7/8"	33 3/4"	45 5/8"	30 1/2"	42 3/8"
48"x48"	59K	7 1/2"	46 5/8"	46 5/8"	55 7/8"	55 7/8"	45 5/8"	45 5/8"	42 3/8"	42 3/8"

FAKRO



Warning! The present drawing is for informational-demonstrative purposes only and as such cannot constitute a basis for performance. All dimensions presented in this drawing should be verified on site. Because of the fact that the drawing is a schematic one, FAKRO shall not assume any responsibility for the actual installation quality on the roof. This drawing is FAKRO's property and cannot be published or used publicly without our written consent.

Vertical and horizontal cross-section:
DEF DU6 FAKRO Flat Roof Window, electrically opened,
Flat, glazing unit DU6

FORMAT:
A4

SCALE:
1:10/1:5

DATE:
12.2020